

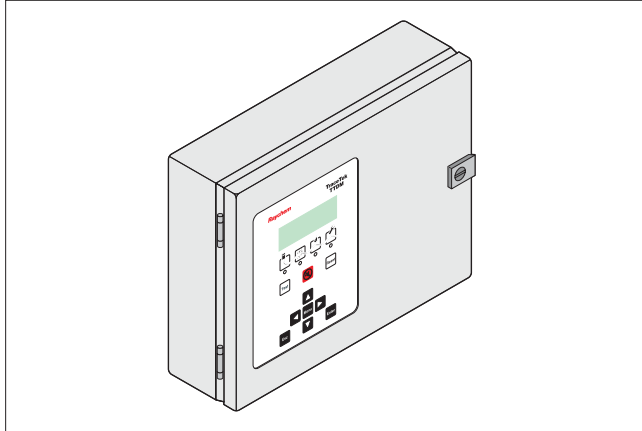

# TTDM-128

## TraceTek Leak Detection and Location Module

### Installation Instructions



#### General Information

Please read these instructions carefully and keep them in a safe place (preferably close to the TTDM) for future reference. These instructions must be followed carefully to ensure proper operation.

The TTDM Alarm and Locating Module has been designed specifically for use with TraceTek sensing cables, point sensors, sensor interface modules and relay modules. The TTDM can directly monitor up to 1500 m (5000 ft) of sensing cable, and large networks of remote leak detection modules.

An external disconnect device and appropriate branch circuit protection (no more than 20 amp rating) should be provided for the TTDM. The disconnect device should be clearly marked as such. Follow all national and local codes and regulations applicable to the installation.

#### Installation items (not supplied)

- Wall fasteners for surface mounting (four screws)

#### Tools required

- Drill or hole punch for electrical conduit entries
- Phillips (cross-head) screwdriver
- Small flat-head screwdriver

#### Storage

Keep the module in a dry place prior to installation to avoid possible damage to internal components.

#### Product Information

<b>TTDM-128</b>	115 Vac $\pm 15\%$ , $-20\%$ ; 50/60 Hz 230 Vac $\pm 10\%$ ; 50/60 Hz
<b>TTDM-128-24V</b>	24 Vac $\pm 5\%$ , $-35\%$ 24 Vdc $\pm 20\%$
<b>Power consumption</b>	6 VA (5 W) for TTDM-128 12 VA (10 W) for TTDM-128-24V
<b>Installation categories</b>	Overvoltage Category II, Pollution Degree 2
<b>Built-in relays</b>	Number: Three (Service, Leak, Fault) Type: DPDT Rating: 5 A at 250 Vac/24 Vdc
<b>Temperature</b>	Storage: $-18^{\circ}\text{C}$ to $60^{\circ}\text{C}$ ( $0^{\circ}\text{F}$ to $140^{\circ}\text{F}$ ) Operating: $0^{\circ}\text{C}$ to $50^{\circ}\text{C}$ ( $32^{\circ}\text{F}$ to $122^{\circ}\text{F}$ )
<b>Enclosure</b>	NEMA 12; IP 54

#### Approvals and Certifications



#### WARNING:

Shock hazard. Shut off power before operating enclosure door.

## TTDM-128 Installation Instructions

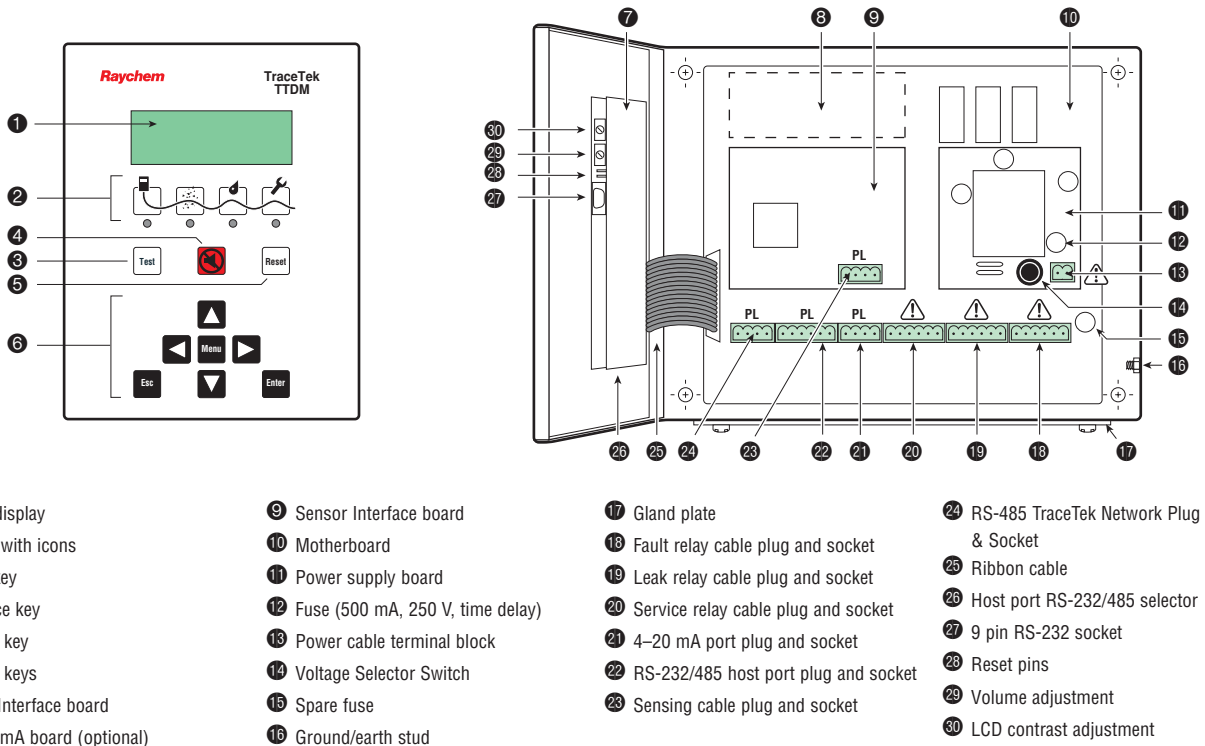

PL indicates power limited circuits

### Installing the TTDM

**Note:** To avoid damage to the unit, store the TTDM module in its cardboard box until construction is complete.

**Important:** The TTDM is an electronic unit. During installation, take the following precautions to avoid damage to its electronic components:

- Handle with care, avoid mechanical damage.
- Keep the electronics dry.
- If handling circuit boards, hold them by their edges to avoid physical contact with electronic components.
- Avoid exposure to static electricity.
- Avoid contamination with metal filings, liquids, or other foreign matter.

### Select the mounting position.

Choose a location indoors where the module will be protected from the elements and temperature extremes.

- Remove the module from its carton. Do not remove the protective film from the membrane on the front of the unit.
- Open the enclosure door using a flat-blade screwdriver or a coin.

**⚠ WARNING:** Ignition hazard. Do not mount the TTDM unit in a hazardous location. Sensing cable connected to the TTDM may (subject to approvals restrictions) be located in hazardous locations, but the module itself must be in an ordinary area.

**Note:** The TraceTek sensing circuit is power limited, so the TraceTek leader or jumper cable and the power supply cable must not run in the same conduit.

### Mounting the Enclosure

Install the enclosure using the four screws in the prepunched 8 mm (5/16-inch) mounting holes with centers as shown in Figure 3. If plastic plugs are in the mounting holes, remove them. **Make sure the rubber elastomeric washers (provided in the shipping box) are aligned to seal around the mounting screws to maintain the NEMA 12 and IP54 ratings.**

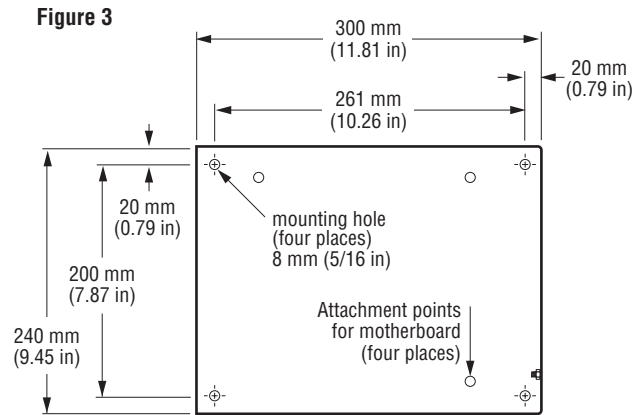

### Making Enclosure Entries Using the Removable Gland Plate

The removable gland plate **17** on the bottom edge of the enclosure provides a location to feed wires into the enclosure (Figure 4). The plate is attached with eight screws. Unscrew these to remove the gland plate, then you can drill or punch holes in the gland plate appropriate for your application. There is sufficient width for up to five 1/2-inch or M20 holes. Remove all metal filings and dust from the gland plate before remounting. Take care not to damage the gasket on the gland plate. You must secure the gland plate ground wire to the chassis ground lug after remounting the gland plate.

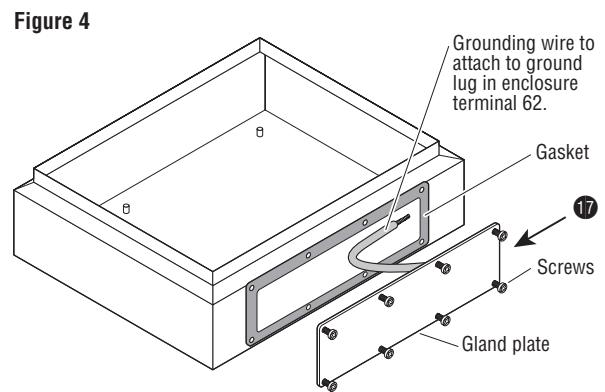

## Connecting the Power Cable and Relays

### Connect the power wiring.

- Open door of TTDM enclosure.
- For 120/220 Vac power supply: select the appropriate voltage using the voltage selector switch **14**.
- Pass the power cable through the gland plate adapter/bushing into the enclosure.
- Connect the ground/earth wire to the ground/earth stud **16**.
- The ground/earth stud is marked with this symbol: ⊕

**Note:** Proper grounding/earthing is important to avoid the possibility of electromagnetic interference.

**Note:** Ground/earth wire must be longer than the other two conductors for strain relief.

- Remove the power cable plug from the socket **13** on the power supply board **11**.
- Connect the power supply wires to the two-pin terminal block **13** on the power supply board. Use L2 for neutral, if present.

**Note:** The terminals can accept wires 10 AWG (4.7 sq. mm) or smaller. We recommend 12 AWG (3.0 sq. mm) wires, with branch circuit protection sized accordingly. Cable should have a temperature rating of 65°C minimum.

- Insert the power cable plug back into the socket on the power supply board **11**.

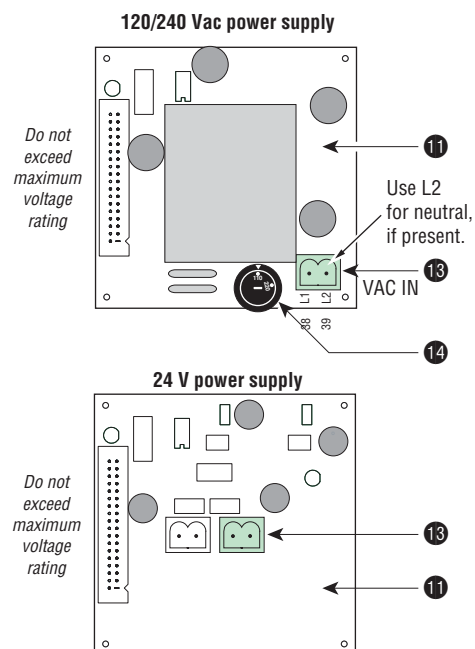

## TTDM-128 Installation Instructions

### Connect the alarm relays.

The TTDM has three relays, for service 20, leak 19, and fault 18. Each relay provides two Form-C relay contacts, and normally open and normally closed contacts are both provided. The relays are **de-energized to indicate an alarm** condition. The illustration shows the relay status in the alarm (de-energized) state.

The illustrations that follow show how relays can be jumpered together to allow remote monitoring of the TTDM status with only a single pair of wires. The TTDM **de-energizes** its relays to signal an alarm condition. Therefore, loss of power, as well as any other type of alarm, would signal the remote alarm.

**Note:** The relay plugs can accept wires 10 AWG (4.7 sq. mm) or smaller. We recommend 18 AWG (1.0 sq. mm) wires. Cable should have a temperature rating of 65°C.

**Note:** Maximum load for relays is 5 A.

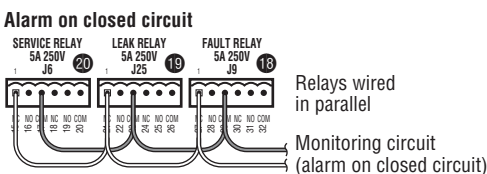
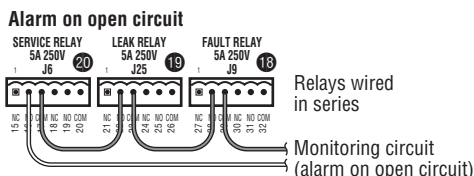
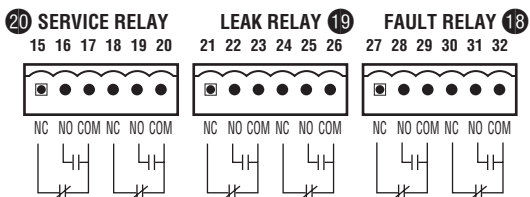

## Testing the Module

### Test after supplying power.

- Close and latch the enclosure door.
- Supply power to the unit. When power is supplied, the green LED illuminates, and the unit goes through a series of self-tests. After the start-up sequence is complete, the module should report a fault alarm (this is normal; there is no sensing cable attached). Press the red Silence key to silence the audible alarm. Verify that the display appears similar to the one shown here (the time and date may be different):

If anything other than the above occurs, check all connections. If unit still does not appear to operate properly, contact a TraceTek representative for assistance.

- Press the Test button. The module conducts a number of self-tests.
- If the tests are successfully completed, record this on the installation record.
- Turn off the power supply to the unit.

### Test with TTDM test plug.

- To conduct a more complete test, use the TraceTek TTDM-CTP test plug (packed in a plastic bag in the TTDM packaging). Insert the plug into the sensing cable socket 23 on the sensor interface board 9.
- Close and latch the enclosure door.
- Supply power to the unit. When power is supplied, the unit will again go through a series of self-tests. If the test plug is in the sensing cable socket, after the module completes the start-up sequence it should sound and display a leak alarm. Press the Silence key to silence the audible alarm. The red Leak LED and green Monitoring LED should both be illuminated, and the screen display should appear similar to the one shown here (depending on the setting).
- If anything other than the above occurs, check all connections. If unit still does not appear to operate properly, contact a TraceTek representative for assistance.
- If the test is successfully completed, record this on the installation record.
- Turn off the power supply to the unit.
- Remove the TTDM-CTP test plug and store it in a secure place for future use.
- If not immediately connecting the sensing cable, or TraceTek network, close and latch the enclosure.

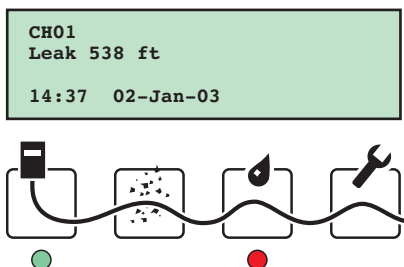
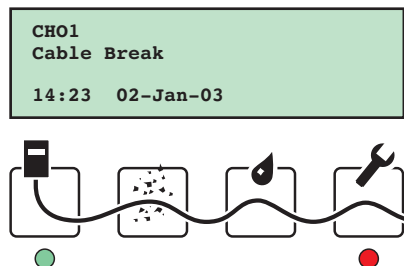

Depending on the units selected, the leak distance should be within the values below:

feet: 527 to 548 ft  
 meters: 160 to 168  
 zones: 11

## Connect the Sensing Cable

If the TTDM will be used to monitor a sensor directly, follow these instructions to connect the sensor to the TTDM. If the TTDM is being used only as a network master, skip to Connecting the TraceTek Network.

### Prepare sensing cable.

Ensure that the sensing cable has been installed and tested in accordance with the instructions provided with the cable.

### Make connections.

- Confirm that power to the unit has been shut off.
- Open the enclosure door.
- Feed the end of the TraceTek Leader Cable (or Jumper Cable) through the gland plate 17 adapter/bushing into the enclosure.
- Remove the sensor cable plug 23 from the socket on the sensor interface board 9.
- Connect the four color-coded wires to the Sensor Interface plug. **Important:** Observe the color coding. If wires are not connected to the proper terminals, the leak detection system cannot operate properly.
- Insert the sensing cable plug back into the socket on the Sensor Interface Board 9.

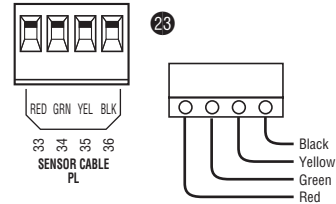

### Install zener barrier, if applicable.

When sensing cable will be located in Class I, Division 1 (Zone 0 or Zone 1 in Europe) hazardous locations, approval agencies require that the sensing cable be protected with a zener barrier between the sensing cable and the TTDM module. Contact TraceTek to select the proper zener barrier.

When installing a zener barrier, wire it in accordance with the instructions provided with the kit.

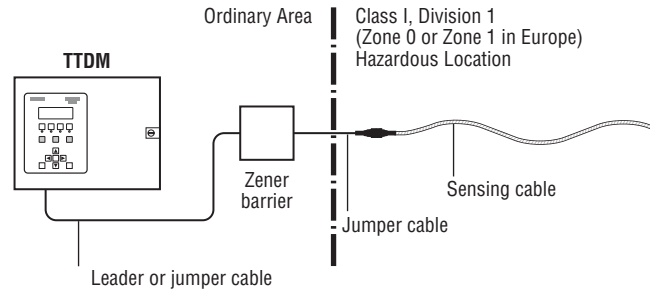

## Connecting the TraceTek Network

If the TTDM will be used as the network master in a TraceTek network, follow these instructions to connect the communication wiring.

**Note:** Some TraceTek network configurations will require different connections for the communication wiring. Please refer to the TTDM-128 User Manual for further details.

### Prepare communication cable.

Ensure that the communication cable has been installed and tested.

### Make connections.

- Confirm that power to the unit has been shut off.
- Open the enclosure door.
- Feed the end of the communication cable through the gland plate 17 adapter/bushing into the enclosure.
- Remove the J10 cable plug 24 from the socket.
- Connect the positive wire to terminal 3 (485+) and the negative lead to terminal 4 (485-) of the J10 cable plug.
- Connect the shield wire to the round lug 16.

**Important:** Observe the polarity. If wires are not connected to the proper terminals, the leak detection system cannot operate properly.

- Insert the J10 cable plug back into the socket 24.

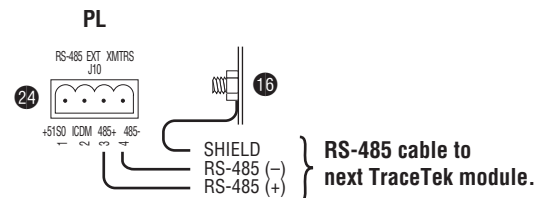

## TTDM-128 Installation Instructions

### Connecting to a Host Computer

There are 3 ways to connect the TTDM to a host computer: hard-wired RS-232, hard-wired RS-485, or standard modular RS-232 cable. For permanent installations, the hard-wired method is recommended (either RS-232 or RS-485 as necessary). The modular RS-232 cable should be used only for temporary connections by trained technicians.

#### Make connections.

- Confirm that power to the unit has been shut off.
- Open the enclosure door.
- Feed the end of the communication cable through the gland plate 17 adapter/bushing into the enclosure.
- Remove the J13 cable plug 22 from the socket.

#### For RS-232 connection:

- Connect the RX, TX, RTS, CTS and DGND wire to terminals 5, 6, 7, 8 and 10 respectively.
- Set the host port selector switch 26 on the User Interface board 7 to the RS232 position.

#### For RS-485 connection:

- Connect the positive wire to terminal 5 (RX/A) and the negative wire to terminal 6 (TX/B).
- Set the host port selector switch 26 on the User Interface board 7 to the RS485 position.
- Connect the shield wire to the grounding lug 16.
- Insert the J13 cable plug back into the socket 22.

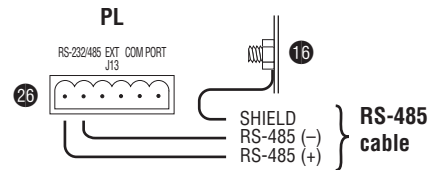
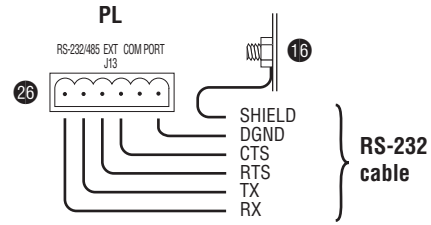

### Start-Up and System Testing

#### Power up the system.

After connections are complete, supply power to the unit. The unit will go through a series of self-tests, and then display the system status. If the sensing circuit is complete and free of leaks or other problems, the green Monitoring LED **only** will illuminate, and the LCD display will appear similar to that shown at right:

If this is not the case, you can find additional information in the *TTDM Operation and Maintenance Manual* supplied with the module.

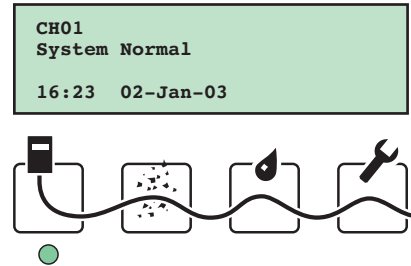

#### Commissioning

Your system should be commissioned by an authorized TraceTek representative. The system map is a crucial part of a TraceTek locating system. The TTDM will give the point along the sensing cable at which liquid has been detected; the map is essential to show its physical location.

**Important:** Store hardware and documentation supplied with the TTDM in a secure place for later use (commissioning, connecting interfaces, operating).

**Tyco Thermal Controls**  
300 Constitution Drive  
Menlo Park, CA 94025-1164  
Tel (800) 545-6258  
Fax (800) 596-5004  
info@tycothermal.com  
www.tycothermal.com

**Important:** All information, including illustrations, is believed to be reliable. Users, however, should independently evaluate the suitability of each product for their particular application. Tyco Thermal Controls makes no warranties as to the accuracy or completeness of the information, and disclaims any liability regarding its use. Tyco Thermal Controls' only obligations are those in the Tyco Thermal Controls Standard Terms and Conditions of Sale for this product, and in no case will Tyco Thermal Controls or its distributors be liable for any incidental, indirect, or consequential damages arising from the sale, resale, use, or misuse of the product. Specifications are subject to change without notice. In addition, Tyco Thermal Controls reserves the right to make changes—without notification to Buyer—to processing or materials that do not affect compliance with any applicable specification.