

TT-JSK-HS18

Splice Kit

Installation Instructions

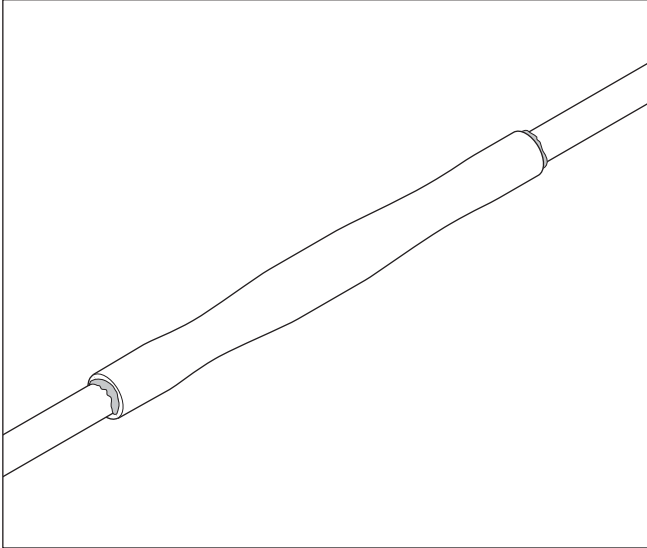

Description

The TT-JSK-HS18 splice kit is used to connect lengths of TraceTek jumper cable (18 AWG). Kit contents include materials for five complete splice connections. This kit is recommended for connections which are exposed to the environment, rather than protected by a junction box.

Tools Required

- Raychem AD-1522 crimp tool or equivalent
- TT-UltraTorch flameless heating tool
- Wire cutters
- Wire strippers (18 AWG)

Kit Contents

Item	Qty	Description
A	20	Red barrel crimps (metal crimp covered by heat-shrinkable tubing, 4 per splice)
B	5	3/4" Diameter heat-shrinkable tubes (1 per splice)

Note: do not substitute kit parts.

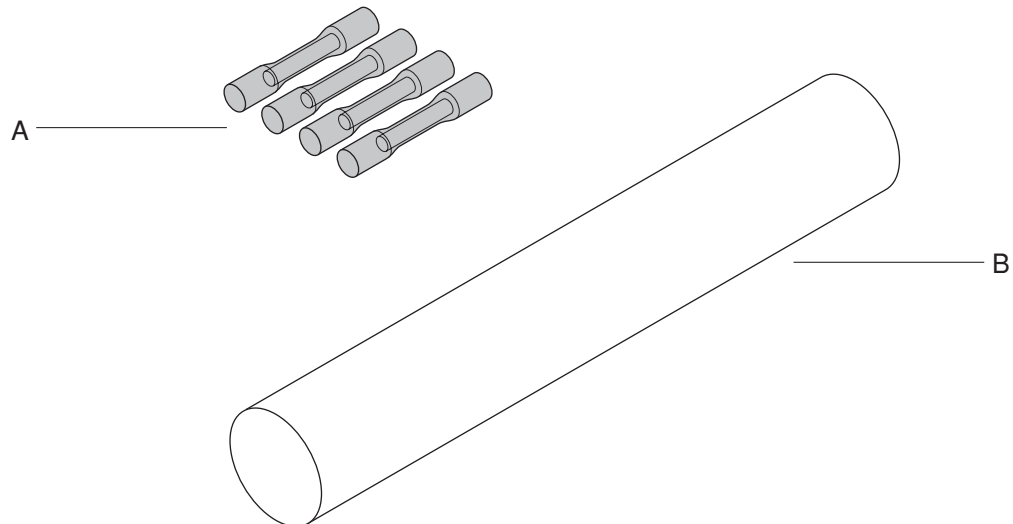

⚠ WARNING: Fire hazard. Heat guns and flameless heating tools can cause fire or explosion in hazardous areas. Be sure there are no flammable materials or vapors in the area before using these tools. Follow all site safety guidelines when working in hazardous areas.

⚠ WARNING: Overheating heat-shrinkable tubing or barrel crimps will produce fumes that may cause irritation. Use adequate ventilation and avoid charring or burning. Consult MSDS RAY/3122 and RAY/5106 for further information.

TT-JSK-HS18 Installation Instructions

1

- Strip the outer jacket 1-1/2" back on the cables to be joined. Do not nick jumper wire insulation. If nicked, cut off and begin again.

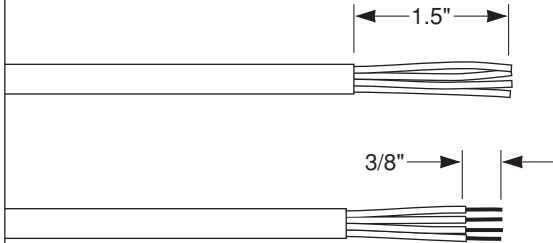

- Strip the insulated jacket 3/8" from end of each exposed wire.

2

- Slide 3/4" diameter heat-shrinkable tube over one end of the cable and move down out of the way.

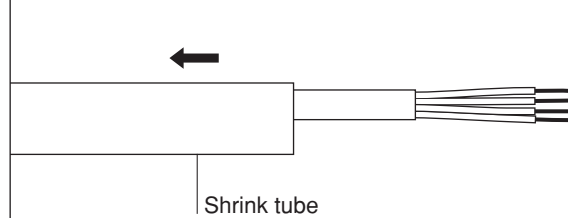

3

- Crimp the exposed wire on one end of the prepared cable end using the Raychem AD-1522 crimp tool and one red barrel crimp. Then crimp the matching colored wire on the other cable to the other end of crimp.
- Repeat for remaining three wires. Make sure colors are matched.

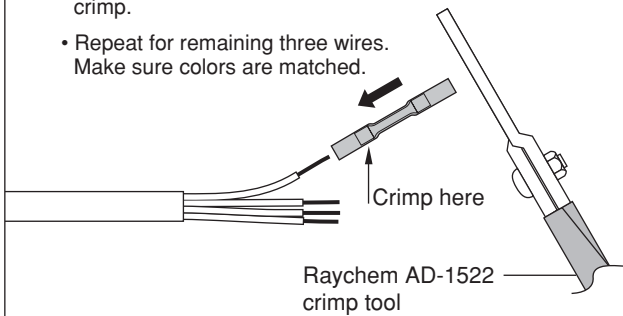

4

- Shrink the barrel crimp tubing down over each of the four wire connections using the TT-UltraTorch flameless heating tool. Ensure that the ends of each barrel crimp are shrunk over the wire insulation at each end.

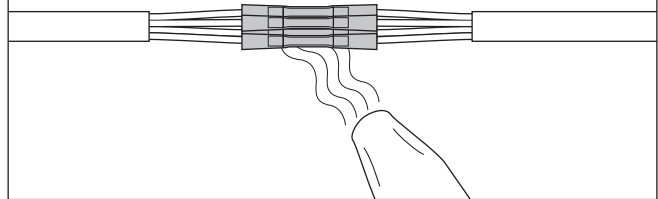

5

- Center the 3/4" heat-shrinkable tube over the connection.

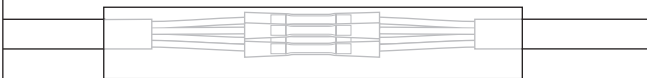

6

- Shrink the heat-shrinkable tube using the heating tool. Begin in the center and shrink towards the ends. If voids are visible at the tubing/cable interface, squeeze lightly, while hot, using a glove or rag to close voids. Do not allow hot adhesive to contact skin.

