

**AT-SZA
Single Zone Alarm**

Product Information

SZA

115Vac +15%, -20%; 50/60 Hz
230Vac ±10%; 50/60 Hz
12Vdc ±20%

Power consumption

7 watt maximum

Relays

Number: Three (2 x Leak, 1 x Fault)
Type: SPDT
Rating: 3 A at 250Vac/24 Vdc

Temperature

Storage: -18°C to 60°C (0°F to 140°F)
Operating: 0°C to 50°C (32°F to 122°F)

Enclosure

NEMA 12; IP54

Approvals



The SZA is approved for use in ordinary areas. The module must be located in an Ordinary Area, but may monitor intrinsically safe TraceTek sensing cables located in Hazardous Locations:

- TraceTek sensing cable in Class I, Division 2, Groups A, B, C, D Hazardous Locations.
- If protected by agency-approved zener barrier TraceTek sensing cable in Class I, Division 1, Groups A, B, C, D Hazardous Locations (Zone 0 or Zone 1 in Europe). Contact your TraceTek distributor/agent to select proper zener barrier.

Additional items

AT-BU Battery Unit c/w battery for 72 hrs operation
AT-BAT Replacement 12Vdc, 7Ah Battery
AT-SZA-SFMF Semi Flush Mounting Flange

General Information

Please read these instructions carefully and keep them in a safe place (preferably close to the module) for future reference. These instructions must be followed carefully to ensure proper operation.

The SZA single zone alarm has been designed specifically for use with TraceTek sensing cables (TT1000, TT3000, TT5000, TT5001 and TT7000). The SZA can monitor up to 100 m (328 ft) of sensing cable, or 10 water detection probes. Optical probes, float switches and level indicators can also be incorporated into the system.

The SZA is designed for use in ordinary areas with temperatures of 0°C to 50°C (32°F to 122°F).

Installation items (not supplied)

- Wall fasteners for surface mounting (four screws)
- Rubber or elastomeric washers to seal at mounting points
- Semi-flush recess flange (optional)

Tools required

- Drill or hole punch for electrical conduit entries
- Phillips (cross-head) screwdriver
- Small flat-head screwdriver

Storage

Keep the module in a dry place prior to installation to avoid possible damage to internal components.

Additional items

AT-BU Battery Unit c/w battery for 72 hrs operation
AT-BAT Replacement 12Vdc, 7Ah Battery
AT-SZA-SFMF Semi Flush Mounting Flange

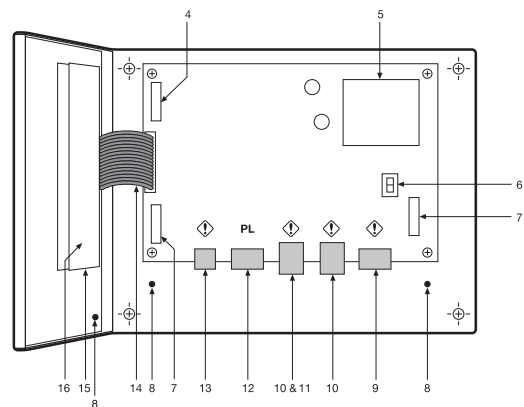
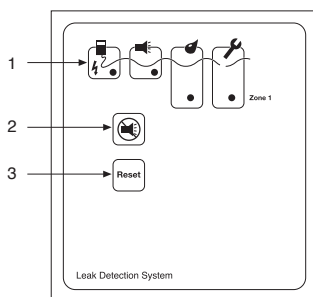

- | | | | |
|--------------------|-------------------------|---------------------------------------|------------------------|
| 1. LEDs with icons | 5. Motherboard | 9. Power cable terminal block | 13. Battery connection |
| 2. Silence key | 6. Voltage selector | 10. Leak relay cable plug and socket | 14. Ribbon cable |
| 3. Reset key | 7. Fuse (1600mA, 250 V) | 11. Fault relay cable plug and socket | 15. Buzzer mute link |
| 4. Spare fuse | 8. Ground/earth stud | 12. Sensing cable plug and socket | 16. Display door board |

WARNING: Shock hazard. Shut off power before opening enclosure door.

PL Indicates power limited circuits.

Note: To avoid damage to the unit, store the SZA module in its cardboard box until construction is complete.

Select the mounting position

Choose a location indoors where the module will be protected from the elements and temperature extremes.

WARNING: Ignition hazard. Do not mount the SZA unit in a hazardous location. Sensing cable connected to the SZA may (subject to approvals restrictions) be located in hazardous locations, but the module itself must be in an ordinary area.

Prepare the module for mounting

Important: The SZA is an electronic unit. During installation, take the following precautions to avoid damage to its electronic components:

- Handle with care, avoid mechanical damage.
- Keep the electronics dry.
- If handling circuit boards, hold them by their edges to avoid physical contact with electronic components.
- Avoid exposure to static electricity.
- Avoid contamination with metal filings, liquids, or other foreign matter.

- Remove the module from its packaging.
- Open the enclosure door using a flat-blade screwdriver or coin.
- Carefully disconnect the ribbon cable from the motherboard.
- Unscrew the four Phillips (cross-head) screws holding the motherboard to the enclosure (see Fig 1). Remove the motherboard, and put it out of harm's way.
- Taking care to protect the User Interface board on the enclosure door, drill/punch entries as required (see Fig 2).
- **Note:** The TraceTek sensing circuit is power limited, so the TraceTek leader or jumper cable and the power supply cable must not run in the same conduit.
- Fit conduit bushings/adapters.
- Remove all traces of metal filings and dust from inside the module enclosure.

Mount the module

The module mounts with four screws with mounting centers as noted in Fig 3. To seal around the mounting screw (necessary to maintain the IP54 rating), use a rubber or elastomeric washer.

Reassemble the module

Note: before replacing the motherboard, ensure that the interior of the enclosure is clean.

- Replace the motherboard and secure it in place with the Phillips (cross-head) screws.
- Reconnect the ribbon cable (taking care not to bend any pins in the connection).
- Close and secure the door of the enclosure.

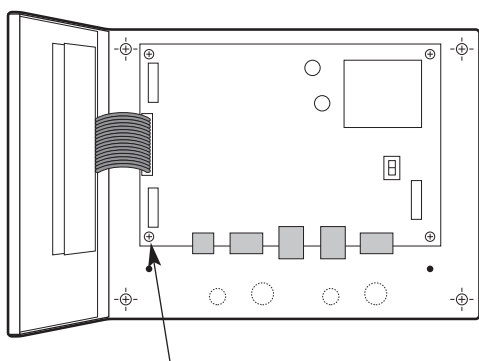

Figure 1 Remove all four screws attaching motherboard

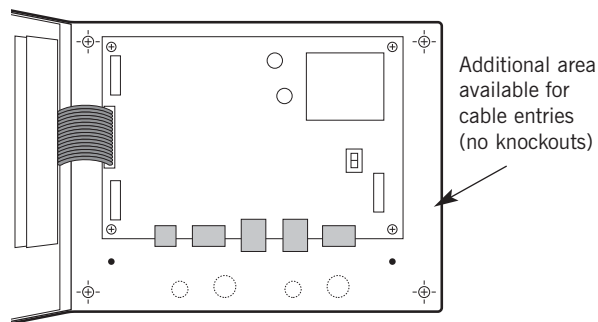

Figure 2

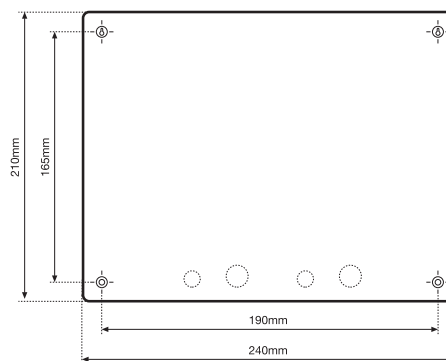

Figure 3

Cable entry knockouts are provided as follows:
 Back plate 2 x 20mm and 2 x 3/4"
 Base of enclosure 3 x 20mm and 3 x 3/4"

Connecting the Power Cable and Relays

Connect the power wiring

- Open door of SZA enclosure.
- Pass the power cable through the knock-out/adaptor/bushing if fitted.
- **Note:** Proper grounding/earthing is important to avoid the possibility of electromagnetic interference.
- Connect the power supply wires to the special three-pin terminal block marked ENL (Earth, Neutral, Live), observing the polarity.
- The electrical supply should be fused at no more than 3amps via an un-switched fused spur adjacent to the unit.
- **Note:** Set the voltage selector switch to the required voltage 220 or 110Vac. The terminals can accept wires 12 to 24 AWG.
- **Note:** Do not exceed maximum voltage.

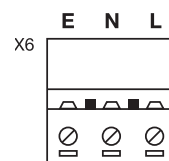

Figure 4

Battery Back-Up

- The unit is equipped with a 12Vdc battery back-up power circuit. If this option is required connect the + and - (positive and negative) battery leads as indicated below (fig 5).
- A separate battery enclosure is available AT-BU which will house a 12Vdc 7Ah battery - AT-BAT.
- Batteries should be tested, maintained and replaced in accordance with the battery manufacturers instructions and recommendations.

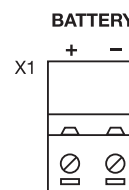

Figure 5

Connect the alarm / break relays

The SZA has three alarm relays, 2 x leak and 1 x cable break. Each relay provides Form C relay contacts, normally open and normally closed. The relays are **energised** to indicate an alarm condition. Each relay is independent of the next. The illustration below shows the relay status when in the alarm (energised) state.

The AT-SZA's "BREAK" (cable break/fault) relay will also indicate power failure as the relay contacts will de-energize to signal an alarm condition. Therefore, loss of power as well as a cable break would trip the relay and any equipment connected.

Note: The relay plugs can accept wires 12 to 24 AWG. Cable should have a temperature rating of 65°C.

Note: Maximum load for relays is 3 amps.

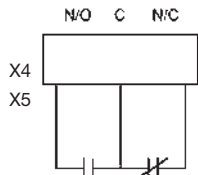

Testing the Module

Test after supplying power

- Close and latch the enclosure door.
- Supply power to the unit. When power is supplied, the green LED illuminates for mains power (red for battery supply). After the start-up sequence is complete, the module should report a fault alarm (this is normal: there is no sensing cable attached). Press the red Silence key to silence the audible alarm. Verify that the red Alarm and yellow Cable Break LED's are illuminated.

If anything other than the above occurs, check all connections.

If the unit still does not appear to operate properly contact your supplier for assistance.

Connecting the Sensing Cable

Prepare sensing cable / sensing probe / other devices

Ensure that the sensing cable (sensing device) has been installed in accordance with the instructions provided.

Make connections

- Confirm that the power to the unit has been shut off.
- Open the enclosure door.
- Feed the end of the TraceTek modular leader cable (or jumper cable) through the knockout / adapter / bushing if fitted.
- Connect the four colour-coded wires to the Sensor Interface plug.

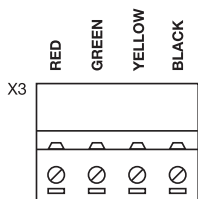

Important: Observe the colour coding. If wires are not connected to the correct terminals, the leak detection system cannot operate properly.

- Insert the sensing cable (SI) plug into the SI socket (item 12 on the product illustration on the first page).

Install Zener barrier, if applicable

When sensing cable will be located in Class 1, Division 1 locations, approval agencies require that the sensing cable be protected with a zener barrier between the sensing cable and the SZA module. A zener barrier may also be used to provide lightning protection for the module when the sensing cable may be exposed to electrical discharges. Contact your distributor / agent to select the proper zener barrier.

When installing a zener barrier, wire it in accordance with the instructions provided with the kit.

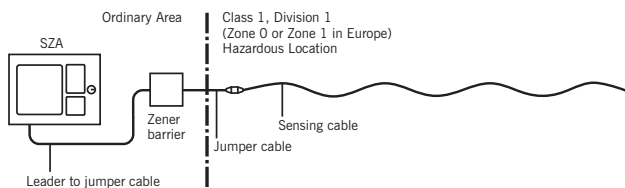

Start-Up and System Testing

Power up the system

Note: Check the voltage selector switch has been set to the correct country / application voltage.

After connections are complete supply power to the unit. If the sensing circuit is complete and free of leaks or other problems, the green monitoring LED will illuminate only.

If this is not the case, you can find additional information in the SZA Operation and Maintenance Manual supplied with the module.

Commissioning

Your system should be commissioned by an authorised Aquitrone™ or TraceTek representative. The system map is a crucial part of the system and should be located adjacent to the unit and within the O&M documents.

Important: Store hardware and documentation supplied with the SZA in a secure place for later use (commissioning, connecting interfaces, operating).

Terminal connection layout

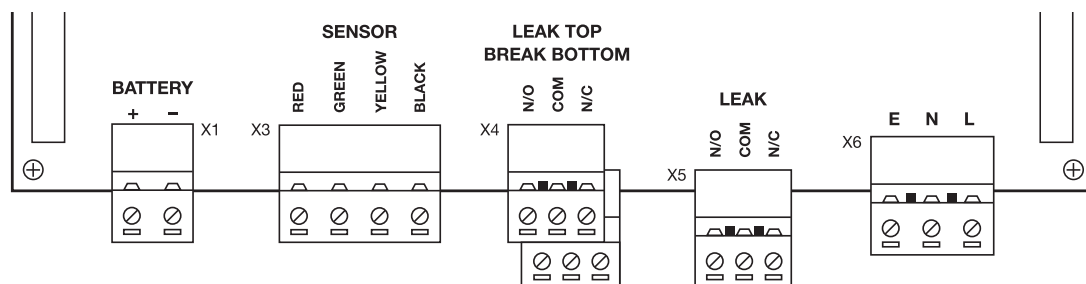

Cleaning the Module

To clean the outside surface, use a damp cloth or sponge. Do not use solvents or abrasive cleaners, and do not open the enclosure while it is wet (it is an electrical device).

Fuse Replacement

The fuse on the power supply board (item 7 on the internal layout drawing) is a 1600-mA, 250-V. Use no other type of fuse or the SZA could be damaged or fail to perform properly. A spare fuse is provided and positioned on the mother board item 4.

Routine Maintenance

It is recommended that the AquiTron™ and TraceTek systems be thoroughly checked twice a year. Such a check will identify conditions that adversely affect the leak-locating capability of the system.

More frequent checks may be required if the sensing cable is repeatedly exposed to leaks, or if construction or repair work is done where the sensing cable may be exposed.

Contact your local AquiTron™ or TraceTek representative for further information on service and maintenance support.

Storage and Handling of Sensing Cable

Despite their rugged construction, TraceTek sensing cables must be handled in a manner appropriate for a sensing device or they may be damaged and require replacement. Therefore, you should follow some basic rules for storing and handling all TraceTek sensing cables:

- Store spare cable in its original container in a clean, dry place until ready for installation.
- Schedule cable and probe/sensor installation after all mechanical, plumbing, and electrical work has been completed.
- Clean the area where the cable is to be installed, and remove any obvious debris or other sources of contamination.
- Do not solder or weld near the cable without providing protection from heat, solder flux, or weld splatter.
- Do not drop tools or floor tiles on the cable; sharp and heavy objects may damage the cable.
- Avoid walking or stepping on the cable. Provide shielding (for example, a half shell of plastic pipe) where additional protection is necessary.
- Do not use tape to secure sensing cable (some tapes and adhesives absorb moisture) or use solvents that could eventually cause an alarm.
- Do not drag sensing cable through contaminants (such as pipe dope, PVC cement, solvents, oil, or dirt).

Note on Cable Cleaning

TraceTek TT1000 and TT3000 use a solid core polymer construction and can usually be easily cleaned with tap water. In extreme cases or when large amounts of cable are contaminated, either cable can be washed in an ordinary dishwasher. Try a water only (no detergent) cycle first and avoid the heated dry cycle. When placing the cable in the dishwasher be sure to tightly connect the male connector on one end to the female connector on the other. Keep water out of the connectors.

TT5000, TT5001 and TT7000 cannot be cleaned without special equipment. These cables normally require replacement after exposure to fuel, solvent, (TT7000 strong acids).

Periodic Maintenance and Testing

Recommended Interval: Perform a functional check per the following procedure at 6-month intervals. Repair or replace all damaged wiring and sensor cables. There are no field repair procedures for the SZA panel. If the module fails to perform the functional tests it must be replaced.

Test Procedure:

1. Normal Operation: Look for Green POWER LED
2. Leak Simulation: For systems using TT1000, TT3000 sensor cable or a detection probe, use a TraceTek Mapping Tool or a small container of water to simulate a leak. After the time delay has expired (maximum 15 seconds) look for the following indications:
 - Red LEAK LED on
 - Green POWER LED on
 - ALARM RELAY in ALARM condition

(Note: This may cause equipment shut down if devices are connected to the ALARM relay contacts)

 - Remove simulated leak
 - Red LEAK LED goes out

For TT5000 and TT5001 systems, simulate a leak condition by tightly bending and holding the sensor cable.

3. Cable Break Simulation: For any sensor system, disconnect any one wire at the sensor cable terminal block or disconnect any connector in the system. Look for the following indications:
 - Yellow CABLE BREAK LED on
 - ALARM RELAY in ALARM condition

Restoring the connection should cause the SZA to return to the normal indications.

Final Check List

1. Complete a system inspection in the presence of the owner.
2. Ensure a plan showing the location of the sensor is available.
3. Check that the following information is clearly visible adjacent to the alarm module:
 - “In case of alarm” instruction.
 - Location of the system map in case it is not installed adjacent to the alarm module.
 - Name and contact number of the person responsible for operating the system.
 - Supplier’s contact name and address.
4. Hand over these Installation, Operating and Maintenance Instructions.
5. Make the owner aware that it is strongly recommended to perform a systems check at regular intervals, at least every six (6) months.

Investigating Leaks and Faults

If the location of a leak is not apparent, it is often useful to subdivide the leak detection circuit, as illustrated below. To accomplish this, it is recommended have a TraceTek Portable Test Box (PTB) and an extra Modular End Termination is used. Contact your local TraceTek representative to obtain these products. Note that the PTB comes with instructions on how to use it.

To segment the system and isolate problems, find a TraceTek sensing cable or jumper cable connection at a convenient point somewhere at the center of the detection circuit. You can then use a PTB to check one portion of the system (to verify circuit integrity, to detect the presence of liquid, and even to determine its location, as the PTB will give you an indication in feet or metres to the point of the leak). If you install an end termination on the other length of cable (going back to the SZA panel), you can use the SZA to check the “front half” of the sensing circuit.

You can further subdivide the circuit, and even test individual lengths of cables, as shown in the third diagram below. Even the most perplexing problems can usually be isolated and resolved using this methodical approach.

TraceTek or AquiTron™
Leak detection alarm panel

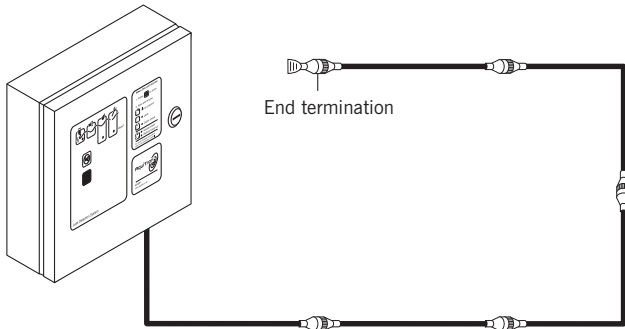

TraceTek or AquiTron™
Leak detection alarm panel

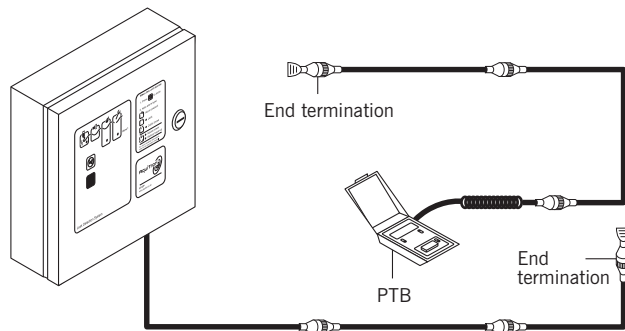

Trouble Shooting

Problem: Leak Alarm, but no leak is found.

Possible Cause: Cable is dirty (TT1000, TT3000).

Action: Clean cable using water (no solvents, acetone, white spirit or turps). Dry the cable and check SZA front panel. Heavily contaminated cable may require replacement. But if dirt is accumulating, cleaning and/or replacement will eventually be required.

Problem: Leak Alarm, but no leak is found.

Possible Cause: Cable is exposed to occasional water spraying (TT1000, TT3000)

Action: It is best to keep the sensor cable at least 1 meter (3 feet) from the outflow of any air conditioner units.

Problem: Leak Alarm, but no leak is found.

Possible Cause: Cable is in contact with sharp metal edges (TT1000, TT3000)

Action: Check the sensor cable for possible points of contact with sharp edges such as the edges of drip trays or the pipe threads on adjustable floor supports, trunking and ducting. Reposition the cable as necessary or insert a small piece of insulating material to prevent the cable from making contact with the metal edge.

Problem: Leak Alarm, but no leak is found.

Possible Cause: Cable is pinched (all cables).

Action: Check the sensor cable for possible pinch points. TT5000 and TT5001 can be tripped if tightly bent or compressed by a heavy object. TT1000 and TT3000 can be tripped by heavy pressure from a metallic object. Check the entire cable installation for pinch points and correct the condition.

Problem: CABLE BREAK indication but cable appears to be intact.

Possible Cause: Loose connections at terminal block.

Action: Check all terminal block screws for tightness. To test the module by itself, use two small pieces of wire to form temporary jumpers from red to green and yellow to black at the sensor cable terminal block. This simulates a very short piece of sensor cable and the yellow CABLE BREAK LED should go off. If the SZA cannot pass the jumper wire test it may require replacement.

Problem: BMS/PLC or other host system detects a fault when the SZA is operating in NORMAL mode.

Possible Cause: Loose connections at terminal block or broken wires between SZA and BMS/PLC.

Action: Check all terminal block screws for tightness. Many installations use a normally closed contact to indicate a normal condition at the SZA. If the wiring between the SZA and the BMS/PLC is loose or open, then the host system will read the open circuit as a fault regardless of the SZA status.

Normal Mode Indications:

LEAK LED (Red)	OFF
CABLE BREAK LED (Yellow)	OFF
POWER LED ON (Green)	ON
ALARM/TROUBLE RELAY	NORMAL (de-energised)

Leak Detection Indications:

LEAK LED (Red)	ON
CABLE BREAK LED (Yellow)	OFF
POWER LED (Green)	ON
ALARM/TROUBLE RELAY	ALARM (energised)

User Action:

1. Locate the spill area, investigate the cause of the spill and take necessary repair actions.
2. Clean up in the spill area and clean and dry the cable / probe, if necessary. LEAK LED will turn off when cable / probe is dried.

Cable Break Indications:

LEAK LED (Red)	OFF
CABLE BREAK LED (Yellow)	ON
POWER LED (Green)	ON
ALARM/TROUBLE RELAY	ALARM (energised)

User Action:

1. Investigate the sensor cable and leader cable for physical damage. Check connectors for damage. Make repairs or replace components as necessary.
2. CABLE BREAK LED automatically turns off when normal sensor cable continuity is restored.

The Alarm Relay automatically returns to the NORMAL position when cable continuity is restored.

Important: All information, including illustrations, is believed to be reliable. Users, however, should independently evaluate the suitability of each product for their application. Aquilar Limited makes no warranty as to the accuracy or completeness of the information, and disclaims any liability regarding its use. The only obligations of Aquilar Limited are those in the Aquilar Standard Terms and Conditions of Sale for this product, and in no case will Aquilar Limited be liable for any incidental, indirect, or consequential damages arising from the sale, resale, use or misuse of the product. Specifications are subject to change without notice. In addition, Aquilar Limited reserves the right to make changes - without notification to Buyer - to processing or materials that do not affect compliance with any applicable specification.

AquiTron is a trademark of AquiTron Limited
Aquilar is a trademark of Aquilar Limited
TraceTek is a trademark of Tyco Thermal Controls

Aquilar Limited

Weights & Measures House, 20 Barttelot Road,
Horsham, West Sussex RH12 1DQ. UK
Tel: + 44 (0) 1403 216 100
Fax: +44 (0) 8707 940 320

E-mail: info@aquilar.co.uk
www.aquilar.co.uk

Master TraceTek Distributor UK & Ireland for
Raychem® TraceTek®
Water, Fuel and Chemical Leak Detection